

FastGene[®] Ultra Cycler

Catalogue Number FG-TC01



Content

1.	FOREWORD	3
2.	WARRANTY	3
3.	CONTACT DETAILS	3
4.	REGULATORY NOTICE	4
5.	IMPORTANT NOTICE	4
6.	SPECIFICATION	5
7.	FEATURES	6
8.	FIRST STEPS	8
9.	PCR PROFILE CREATION AND EXECUTION	10
10.	PCR FILE MANAGER	16
11.	MANUAL BLOCK TEMPERATURE CONTROL	18
12.	CONFIGURATION TOOLS	19
13.	USER TIPS	22
14.	TERMS OF USE	23

1. Foreword

Thank you for purchasing the FastGene® Ultra Cycler. You are now one of the growing number of highly skilled customers worldwide to adopt the FastGene® Ultra Cycler as their preferred thermal cycling engine.

Our philosophy has been to generate the user friendly yet powerful cycling workhorse. We trust you will be most pleased with our product however always welcome any suggestions you may have to make our products better for the future.

2. WARRANTY

The FastGene® Ultra Cycler is warranted against defects in materials and workmanship for 1 year. In case of any defects occurring in the instrument or accessories during this warranty period, Nippon Genetics Europe will repair or replace the defective parts at its discretion without charge.

The following defects, however, are specifically excluded:

- Defects caused by improper operation.
- Repair or modification done by anyone other than Nippon Genetics Europe or an authorized agent.
- Damage caused by substituting alternative parts.
- Use of fittings or spare parts supplied by anyone other than Nippon Genetics Europe.
- Damage caused by accident or misuse.
- Damage caused by disaster.
- Corrosion caused by improper solvent or sample.

For any inquiry or request for repair service, contact Nippon Genetics Europe or your local distributor. Please send a message containing information about the model and serial number of your instrument.

3. Contact Details

Please contact us for additional information: info@nippongenetics.eu

Please contact our support: support@nippongenetics.eu

NIPPON Genetics EUROPE GmbH

Binsfelder Strasse 77

52351 Dueren

Germany

Fon: +49 2421 55 496 0

Fax: +49 2421 55 496 11

4. REGULATORY NOTICE

IMPORTANT: This Nippon Genetics Europe instrument is designed and certified to meet safety standards and EMC regulations. Certified products are safe to use when operated in accordance with the instruction manual. This instrument must not be modified or altered in any way. Alteration of this instrument will:

- Void the manufacturer's warranty
- Void the safety and EMC certification
- Create a potential safety hazard

Nippon Genetics Europe is not responsible for any injury or damage caused by the use of this instrument for purposes other than those for which it is intended, or by modifications of the instrument not performed by Nippon Genetics Europe or an authorized agent.

5. IMPORTANT NOTICE

Please, read the installation instruction carefully before installing the FastGene® Ultra Cyclor. This instrument is intended for clinical and research laboratory use for DNA amplification and it must be operated only by specialized personnel aware of the potential risks associated with the chemical, physical and biological agents normally used with this unit.

6. Specification

Thermal Cycling Technology	High performance active heating and cooling using 6 peltier elements & 3 precision sensors
Temperature Range	4 °C–99 °C
Temperature Accuracy	±0.5 °C over full range, typically < ±0.1 °C at 60 °C
Temperature Uniformity	±0.3 °C, 30 seconds after target (range 40 °C – 90 °C) Typically < ±0.1 °C at 60 °C
Temperature Resolution	0.1 °C increments
Heating/Cooling Rate	Up to 5 °C/sec (Peak) heat & cool (block)
Well Configuration	96-Well block supporting: 0.2 mL tubes or strip tubes with flat or domed caps; 96-well high- or low skirt plates with strip caps, adhesive cover, or oil overlay
Linear thermal gradient (Available selected regions only)	Programmable 0 – 24 °C across block width (12 wells)
Condensation control	Automatic utilising applied pressure heated lid
Heated Lid Temperature Range	Controllable 60 °C–115 °C
Dimensions	W 180 mm (7") D 285 mm (11.2"); 350 mm (13.8") including cables H 190 (7.5") mm lid closed: 340 mm (13.4") lid open
Weight	5.5kg (12.1 lbs)
Colour	Gray on black
Electrical	100–240 VAC @ 4 Amp (50/60 Hz) Automatic voltage sense Standard IEC Inlet plug
External Interface	USB interface to Windows XP / Vista based PC USB host port for memory stick, mouse, keyboard etc.
Internal Interface	Embedded graphical controller with 7" widescreen touch sensitive colour backlit display
Software	Supplied with unlimited user license. Free upgrades available via web download.
Internal Memory	256MB, enough for 10,000+ saved profiles
Functionality	Multiple thermal zones, Touch Down/Up, Long Range, Thermal Gradient, Program Pauses, Temperature Graphing, On-screen Help, User Accounts, Profile Load and Saving, Manual Mode, USB File Transfer, Post Run Reporting, Auto restart and more.
Included Accessories	Power Cable, User manual, Touch Screen Stylus
Warranty	1 year (prolongable)
Specification Operating Temperature	10 °C – 28 °C ambient air temperature

7.Features

➤General

The FastGene® Ultra Cycler is a high performance block cycling system configured and optimised for Industry standard 200 µl individual or strip tubes (domed or flat-capped) or 96-well plates (low or high skirt) with strip caps or adhesive film seals for reaction volumes 5 – 80 µl. It incorporates state of the art electronics, precision quality Ferrotec™ peltier devices and a flexible user interface accessed via a vivid touchscreen display.

➤Configuration

The FastGene® Ultra Cycler utilises six Peltier devices to actively heat and cool the block between 4 °C and 99 °C. These are arranged into three zones with independent sensing and control capabilities.

➤Gradient

Thermal gradient technology enables a varying temperature to be set across the reaction wells of the block. Applications of this feature include the ability to optimize the annealing temperature of an assay in a single experiment by determining the temperature of the wells that yield the best result. The FastGene® Ultra Cycler is capable of generating a gradient of between 0 °C and 24 °C across the block. The software interpolates and displays the temperature of each column of wells in real-time during a run.

Thermal Profile Engine

The FastGene® Ultra Cycler has a powerful thermal profile engine implemented within. A profile may contain up to 99 events. Each 'event' can be either a hold at temperature, thermal ramp or up to 10 step cycling with up to 99 repeats. Any event or step can contain gradient, touchdown or long range features. An almost unlimited number of profiles may be stored on the device for re-running. Despite its capabilities profile setup is straightforward.

➤Long Range

The Long Range feature enables the time of a particular cycling step to be automatically increased or decreased by a preset amount over a specified range of cycle repeats. The Long Range increasing time mode feature is often used to provide gradually extended times for enzymatic polymerization of longer products during later cycle repeats of an amplification reaction. It is most useful for targets longer than about 1kb. Long Range decreasing time mode can be used to shorten the total run time. During later cycles the majority of enzymatic polymerization is occurring on previously generated amplicons which are shorter in length than the original template. Shorter hold times are often sufficient for polymerization of these shorter length products.

➤ Touch Down

The Touchdown function enables the temperature of a step to be automatically decreased by a preset amount over a range of successive cycle repeats. Its primary use is as a mechanism to minimise primerdimer artifacts by gradually decreasing the annealing temperature during initial cycle repeats of an amplification profile.

➤ Pause or Infinite Holds

The infinite hold function allows the user to pause the profile at any number of pre-programmed points with an audible beep. The current set temperature is held indefinitely until the Continue button is pressed. Holds are useful if there is a need to remove tubes or add reagents at a particular point in a run.

➤ Auto Restart

The FastGene® Ultra Cyclor is able to restart a run if power has been lost for any reason during cycling. Once power is restored the run will be resumed from the last step taken. Care should be taken with the reaction results as the power may have been off for a considerable amount of time.

➤ Rate Limiting

The FastGene® Ultra Cyclor is able to limit the rate of heating and cooling during a run. This is controllable between 0.1 °C/sec and 2.5 °C/sec. This is useful for chemistry that has only been verified at the lower ramp. This feature is not available in manual mode. The rate limit may be applied globally (to all transitions), individually (to particular step transitions) or not at all giving the maximum achievable ramp rates.

➤ Manual Control

The FastGene® Ultra Cyclor also supports Manual Mode control. This mode enables the user to set the block to a specific temperature quickly without creating a thermal profile. This function is useful for incubating reactions such as DNA digestion or ligation. Manual Mode also supports thermal gradient.

➤ Evaporation Control Heated Lid

The FastGene® Ultra Cyclor employs a heated lid design to keep the air contained within the tube hotter than the reaction volume. This causes any evaporation to condense back into the cooler reaction liquid thereby eliminating the need for oil or wax condensation overlay.

➤ User Interface

The FastGene® Ultra Cyclor has a 7" colour touch screen giving a vibrant and flexible means of run setup and monitoring. This internal graphical user interface controller provides a powerful yet intuitive and easy to use interface.

New software features and updates are regularly incorporated and available as free upgrades via web download.

8. First steps

Plug the unit into a power outlet and power the unit on with the switch located on the rear of the unit. Do not worry about selecting the correct power voltage for your country. The FastGene® Ultra Cycler is designed to operate in any country in the world with no changes. The unit is also designed to be resistant to power surges and drop-outs that occur in countries with less reliable power grids.

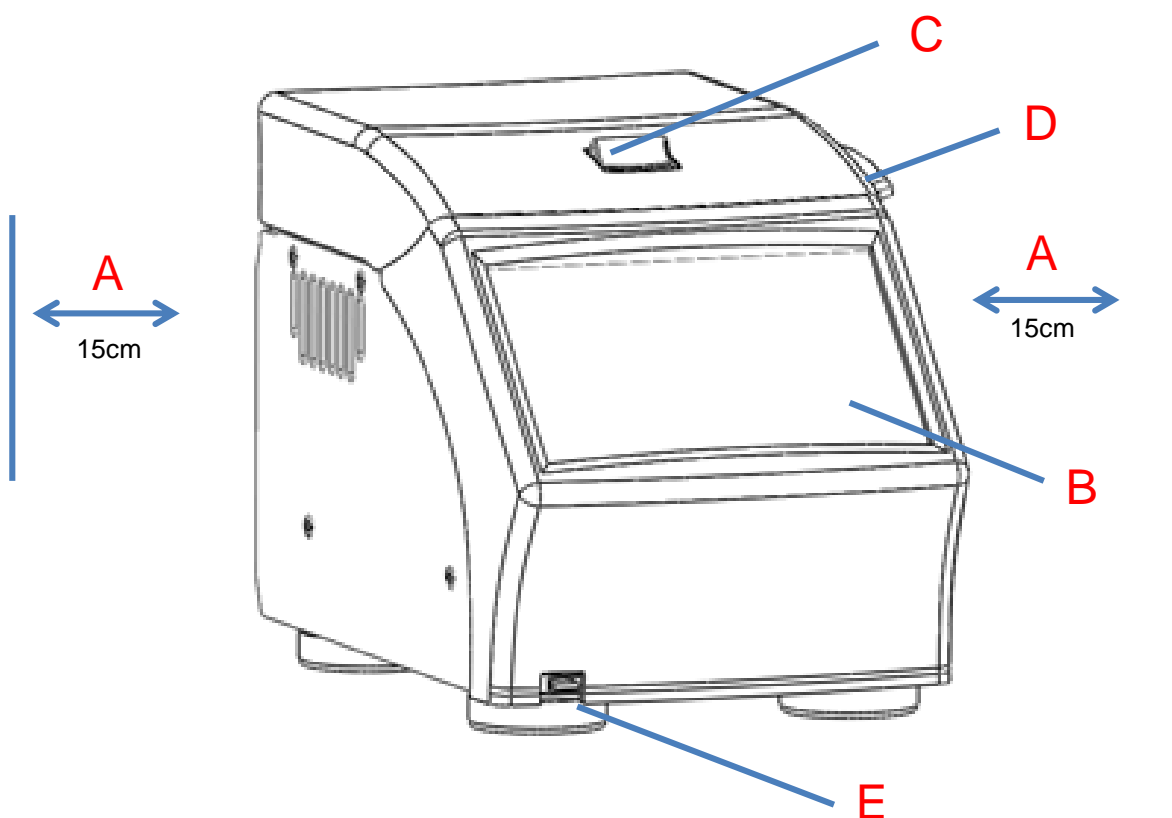

A – The exhaust air vents out of the sides of the unit. Ensure there is at least 15cm gap on both sides between the device and any wall or other object.

B – The screen is touch sensitive. Always use either your finger or the stylus provided. Never use the tip of a pen, pencil or anything sharp as this will damage the touch sensitive film.

C & D – To open the lid press the release lever C backwards with your thumb and lift the lid using the handle D

E – Front USB port for connecting to either a USB memory stick or a USB mouse. Note that the system will only detect devices plugged in after the system has powered up and the software initialised.

On power up the Ultra Cycler will display the logo and take a few moments to initiate the software. After power up the unit defaults to the main screen from where all features may be accessed.



The 4 screen icons provide access the following features:



PCR EDITOR – Takes you to the page where you can create or edit a new thermal profile and then commence it running. This is described in detail in section 9.



PCR RUN MANAGER – Takes you to the page where you can select files that are stored on the machine to edit or run or copy to or from a USB memory stick. This is described in detail in section 10.



MANUAL INCUBATION – Allows immediate manual setting of block temperature. This feature is described in detail in section 11.

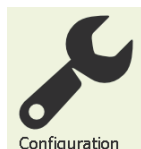

CONFIGURATION – Takes you to the configuration page allowing where you may configure certain machine options. This is described in detail in section 12.

9. PCR Profile Creation and Execution

From the 'Home' screen the 'PCR Editor' icon will bring you to the experiment editor page. Here is where you create and edit thermal profiles for execution on the device.

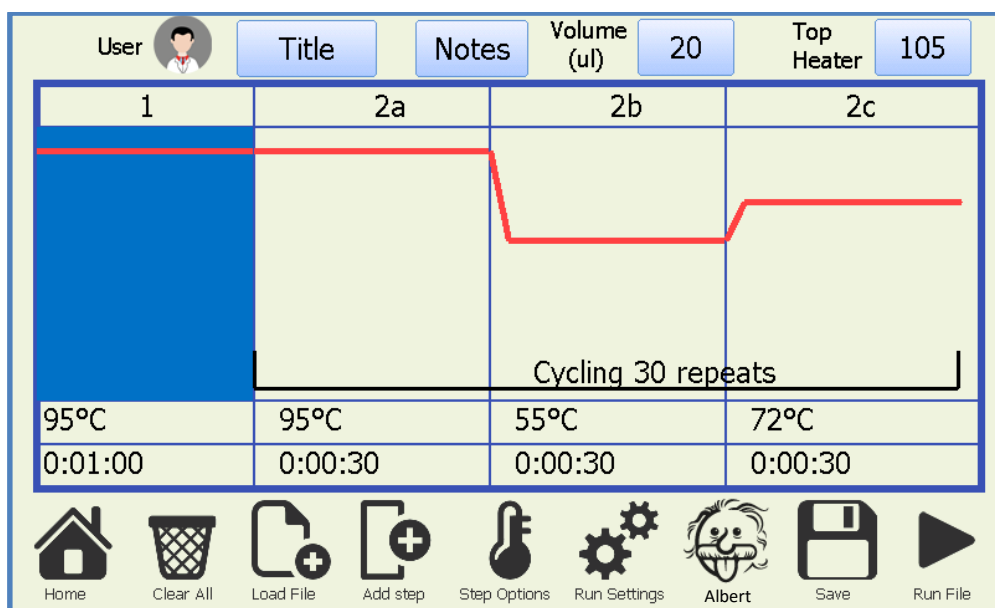

The central area of this screen displays the current thermal profile; note that if there are no steps added it will be blank. To edit either the temperature or time of any step click on the number you wish to edit. Click on the cycle number to edit the number of cycles in a cycling event. To select a step click on the central area of the step you wish to edit. Once a step is selected you may use the step options for advanced options of that step. If there are more steps in the profile than can be displayed on the screen then arrows will appear which let you scroll through the profile.

The following is a list of the icons and their functions.



User

– Touching on the user icon will take you to the user account screen where you can log in as a certain user or further access the user account control screen create, edit and delete users. Any file load and save access on the instrument will be under a directory of the currently logged in user, or in the default directory.

Title

– Allows you to name your experiment profile

Notes

– Allows you to store any extra information you require with your experiment profile

Volume
(µl)

20

– Allows you to set the liquid volume of your experiment profile. Note that this is for your reference only and does not make any difference to the reaction.

Top
Heater

105

– Allows you to set the temperature for the top heater evaporation control in the range 60 – 115 °C. For normal operation use 105 – 115 °C.



Home

– Takes you back to the home screen, note that your thermal profile will not be lost if you leave this screen and you can return to this screen again later to continue editing.

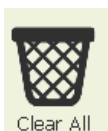

– Will clear all the steps in the current profile. You will be prompted beforehand to confirm.



– Loads a pre-saved profile from the internal flash memory. The FastGene® Ultra Cycler displays a list of the saved files on the unit in the directory of the currently selected user. If no user is selected it will show the files saved in the default user directory. To access a different user's files you need to log in as that user. . For convenience you may also log in as a user from within the load and save page.



– Allows a given profile to be saved to internal flash memory disk. The unit has very large internal memory allowing many thousands of profiles to be saved. Saving a profile also stores the device options configurable under the settings menu, i.e. top heater temperature and other functionality. You may enter any valid file name for saving. Profile file will be saved to the current user directory or the Default directory if no user is selected. For convenience you may also log in as a user from within the load and save page.



– Will display the add step menu so you may choose what type of step you wish to add and select where to add it, either at the end of the currently entered profile steps or after the currently selected step.

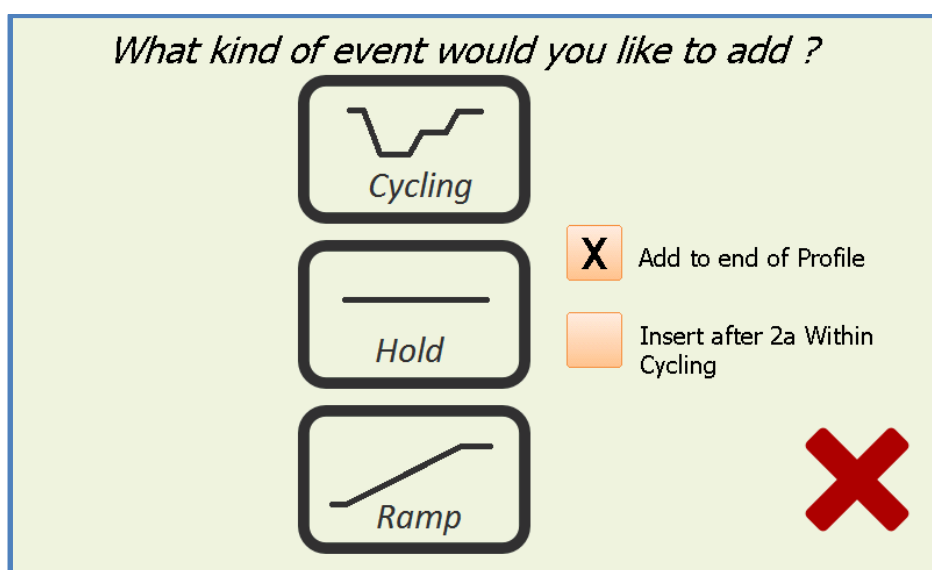

– HOLD will add a basic step pre populated for 60 °C for 30 seconds

– CYCLING will generate a multistep cycling event. You will be prompted to enter the number of steps in the cycling and number of repeats. The parameters of the steps may be entered on the profile editor once the cycling event has been added. By default, they will all be set to 60 °C for 30 seconds.

– RAMP event allows the block temperature to be ramped either up or down between two set temperatures over a pre-set length of time. The block target temperature is updated every second and with a 0.025 °C minimum step resolution. It may be performed either with or without a gradient across the block. After selecting ramp an advanced screen is displayed allowing the entering of the initial and final ramp temperatures along with the time. If the gradient option is selected both the left and right temperatures may be set separately and the predicted well temperatures can be shown by clicking the *Gradient Temps* link.



- Touching step options will give you options for the currently selected step.

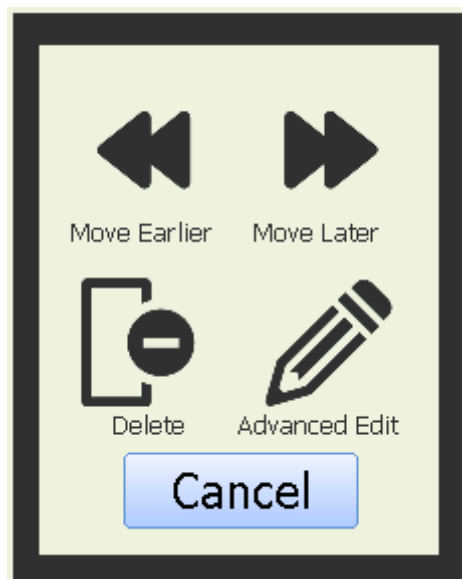

- Any selected step may be moved earlier or later within the thermal profile. When moving a step that is contained within a cycling event if it is the first step of the cycling selecting move earlier will move the entire cycling event earlier. Likewise moving the last step of a cycling event later will move the entire cycling event later.
- Advanced edit will display the following advanced step editor screen.

Advanced Time and Temperature Options

Temp Initial (°C) 55 Temp Final (°C) 60 Steps 5

Hold Time (s) 0:00:30

Gradient
 Touchdown Hold Temperature Varying over Cycles
 Long Range Hold Time Varying over Cycles

Limit the Ramp Rate to this Temperature

Use Global Setting
 Use Custom Setting

2.5

Done

Within this screen there are numerous options. If the gradient option is selected both the left and right temperatures may be set separately and the predicted well temperatures can be shown by clicking the *Gradient Temps* link. If the step is located within a cycling event then there are also options for Touchdown and Long range features available. Selecting these checkboxes will display extra buttons to configure these features.

Touch Down – allows for the temperature of a given step within a cycling event to be

progressively increased or decreased from an initial value to a final value over a defined number of steps.

Long Range – allows the hold time of a given step within a cycling event to be progressively increased or decreased from an initial value to a final value over a defined number of steps. Any or all of the steps within a cycling event may use these features. The following picture displays the same screen with all options (*Touch Down & Long Range*) enabled.

The custom ramp rate limiting option enables the transition rate to this particular temperature step to be set to a specific rate independently of any other step transitions. The rate is only settable in the range 0.1 – 2.5 °. If global setting is selected (default) then the global ramp rate limiting value will be used for the transition if it is enabled otherwise the maximum achievable system ramp rate will be used (default).

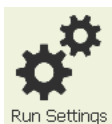

Run Settings

– Takes you to the run settings page, see section 7 for detailed explanation.



Albert

– *Albert*, the PCR Assistant - enables the user to configure easy to moderate complexity profiles in just moments.

Albert - The PCR Assistant		Temperature (°C)	Time (mm:ss)	
<input type="checkbox"/>	cDNA	50.0	30:00	X
	Preheat (Activation)	95.0	1:00	
	Denaturation	95.0	0:30	
	Anneal	55.0	0:30	Cycles 30
<input checked="" type="checkbox"/>	Extension step	72.0	0:30	
<input checked="" type="checkbox"/>	Post Cycling Extension	72.0	5:00	
<input type="checkbox"/>	Hold on Completion	8.0		✓
<input checked="" type="checkbox"/>	Top Heater (°C)	105	Sample Volume (ul) 50	

The *Albert* screen displays each of the steps which occur in a typical range of profiles. At a minimum there are 3 steps, Preheat and then denaturation and anneal which are cycled. You may enable up to a further 3 steps (cDNA, Extension & post run hold) by clicking on the corresponding check boxes. Each of the steps will be executed in the order they are shown arranged down the screen with the Denaturation, Anneal and Extension (if enabled) steps being cycled. After the amplification run has been completed the temperature may be held at a defined temperature until the user disables the unit. To adjust any of the parameters click on the corresponding time or temperature boxes and a keypad will be presented allowing entering of new numbers. The number of cycles can also be adjusted between 1 (single execution, no loops) and 99 cycles. On Gradient instruments these features may be enabled for the anneal step.

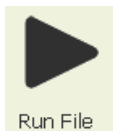

Run File

– Will start the created run. A confirmation screen will appear allowing you to review the profile in a text based format.

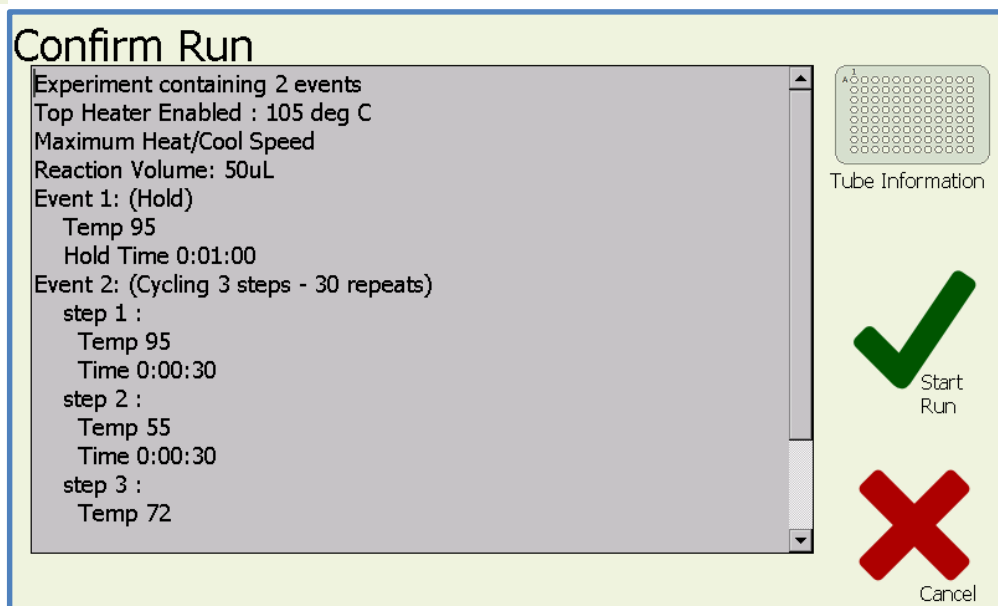

Click on OK to commence run execution. Once the profile is confirmed, if the 'Use Top Heater' checkbox option is selected (default) then you will be prompted with a screen asking if you wish to wait for the top heater to reach target temperature before commencing the run. If you select to wait for the top heater to achieve temperature a waiting screen will be displayed. You may skip the waiting step at any time if you wish to commence the run immediately. Depending on the set temperature of the Top Heater it will take up to several minutes to pre heat to this temperature.

When the run commences the software will automatically proceed to the 'Run' screen. You are not able to modify the profile once a run has commenced but you may save or edit it after it completes or is terminated.

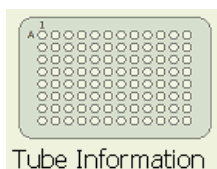

Tube Information

– Select “Tube Information” to view important information about use of different plastic ware. This is for user information purposes only. The following important points should be noted :

- **When using a 96 well plate the silicone mat (pad) should be placed over the plate seal before closing the lid. This helps provide even sealing pressure to the plate seal and helps prevent unwanted evaporation from the reaction mixture should the plate sealing film leak slightly**
- **When using less than the full 96 wells of individual tubes, spread them evenly across the plate to help even the heated lid pressure.**
- **When using strip tubes, if less than the full 96 block, spread them evenly across the plate to help even the heated lid pressure.**

Once the run commences the run screen will be displayed.

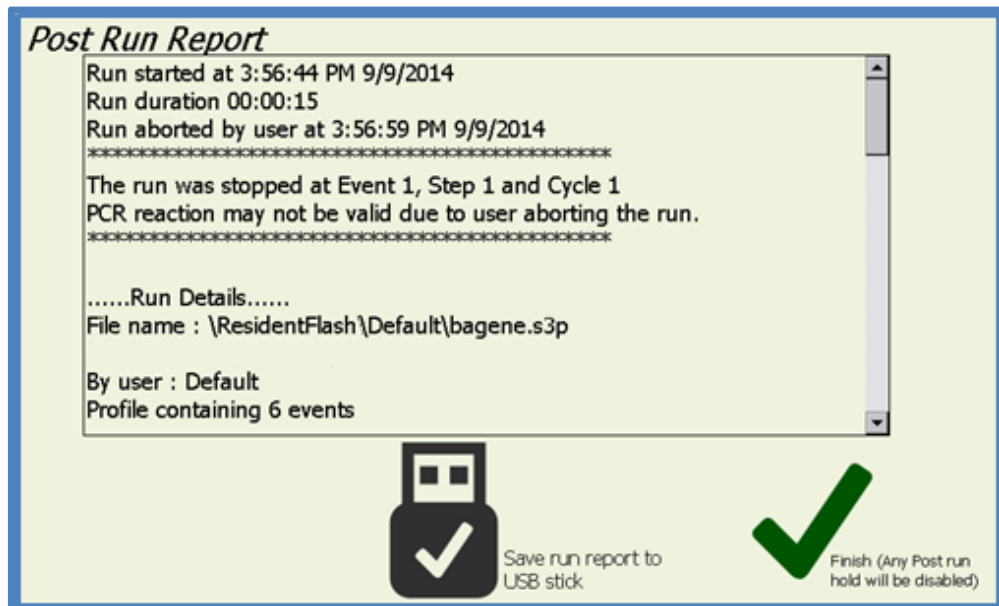

The top section of the screen will display the thermal profile. The currently executing step will be highlighted blue. Steps that have been completed are displayed grey. The left section of the screen displays the system temperatures. Note that the liquid temperature is calculated mathematically as it cannot be measured in situ. The centre screen section shows the last 5 minutes (after run initiation) of block temperature. If gradient is enabled for a step then the left, centre and right bank temperatures will be displayed. The right section of the screen contains the run controls which allow you to pause or stop the run.

On run completion the post run report screen will show and if enabled an audible alarm will sound. The alarm may be muted by pressing the mute alarm button which is only visible while the alarm is sounding. The post run report can be saved as a text file to a USB memory stick for inclusion into lab books etc. Post run reports are also saved to internal memory however to prevent the memory filling up only the 10 most recent reports are kept and any older ones are deleted.

10.PCR File Manager

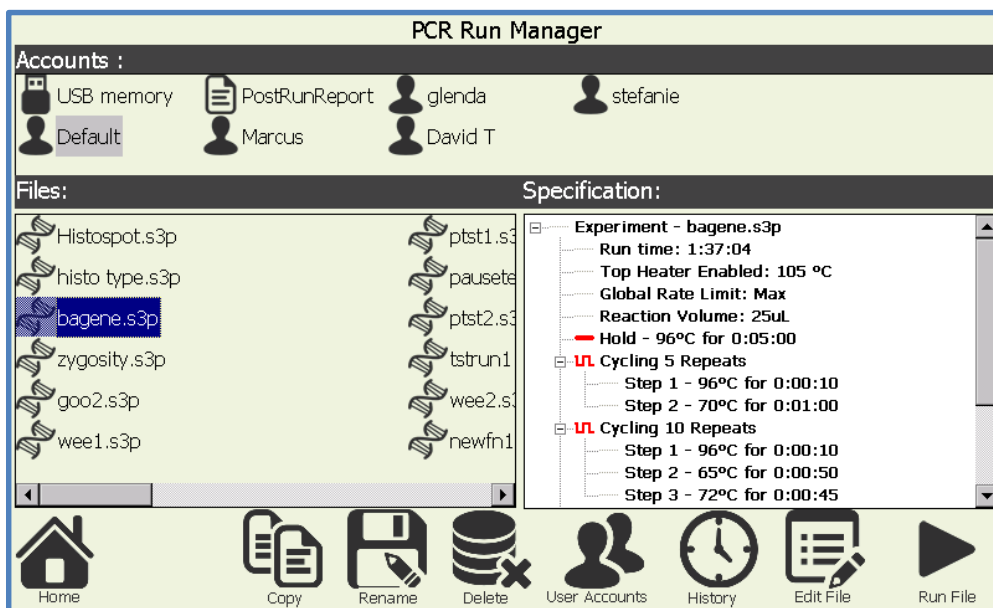

The PCR run manager gives access to all the stored files on the instrument and provides numerous functions. Selecting any of the user directories in the top “Accounts” section will display all of the files in that directory. Selecting a file in the “File” section will then display the run profile in the right section of the screen. Any of the post run reports may also be displayed in the same way.



- The Copy, Paste, Rename & Delete functions allow you to perform normal file management type functions. To transfer files between users or to / from the USB memory select the chosen file and press copy then select the destination user account directory (or USB) and then select paste. Note that if the file name already exists in the destination then it will NOT be copied. Note that when a USB memory stick is plugged into the unit it may take several moments before it is detected. You may select multiple items at once by touching away from the file name and then drawing dragging the selection box around several file names.



- Will display the user accounts page



- Will open the selected file for editing and go to the PCR editor page.

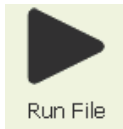

Run File

– Will run the selected file. See section 9 for a description of the run confirmation and execution process.



History

– Will display up to the 5 most recently executed runs by the currently logged in user. You may select one of the runs and choose to run it again.

Recently run programs by : Default

	Name	Date run	Result
	Unnamed	3:53 PM 9/9/2014	Completed
	bagene	10:20 PM 9/7/2014	Aborted
	Unnamed	5:06 AM 9/7/2014	Aborted
	dtmax	3:28 AM 9/7/2014	Aborted
	dtmax	3:24 AM 9/7/2014	Aborted



Run Program Again



Cancel

11. Manual Block Temperature Control

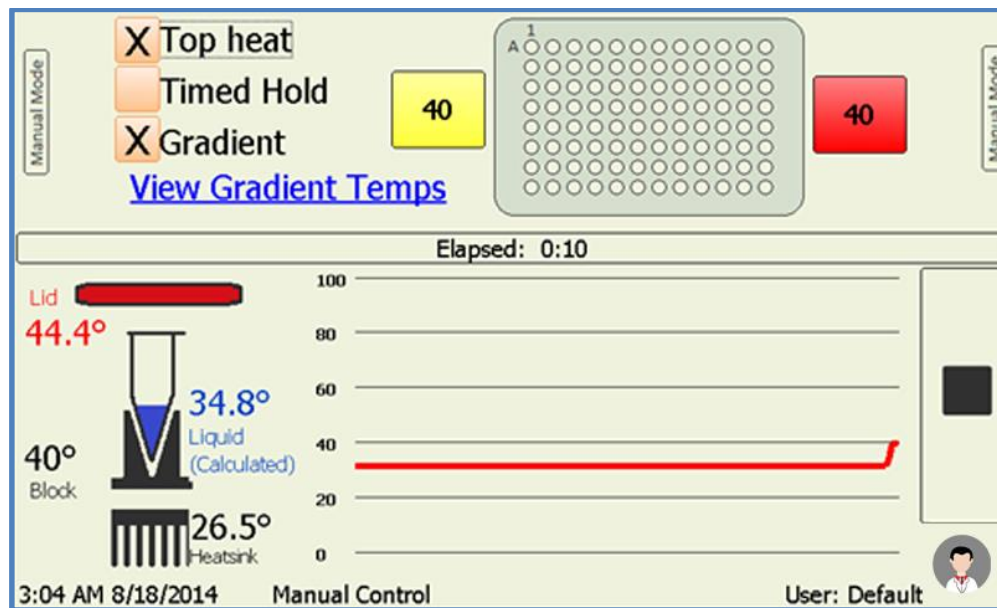

The manual mode screen allows immediate manual setting of the block temperature. To activate this mode simply press the 'play' or start button. Terminating the mode is achieved by pressing the 'stop' button. To Program the set temperature, press the temperature button to the left of the block image and enter the desired value. You may program the temperature set point to 0.1 °C resolution. If the 'Gradient'* checkbox is checked the 'Temp Right' button appears and you are able to set different temperatures for both the left and right sides of the block with a roughly linear thermal gradient presented between the two outer well sides. You may click the "View Gradient Temps" link to check the predicted column temperatures. To enable the Top Heater evaporation control, click the 'Top Heat' checkbox. The target temperature of the top heater is configured under the Configuration → Settings menu. Note the top heater will take a few minutes to reach its operating temperature. The left side of the screen displays the temperatures of the system.

The "Timed Hold" feature allows the user to enter a countdown time after which an alarm will sound and once "OK" is clicked in the notification box the hold temperature will be disabled and return to ambient temperature.

12. Configuration Tools

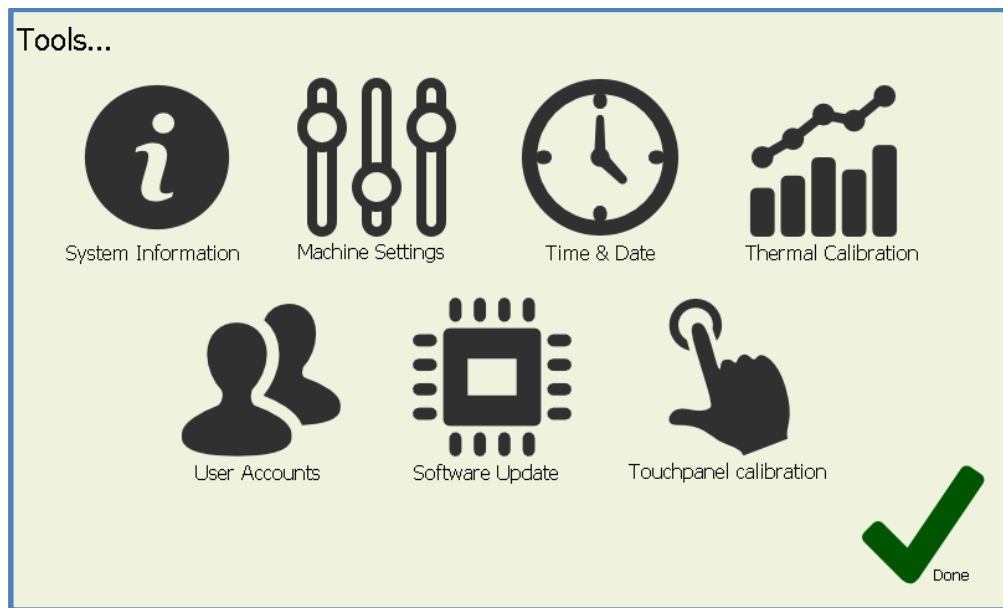

The configuration page provides access to the following features.

SYSTEM INFORMATION– Displays a general information screen which includes such information as serial number, software and hardware version numbers. The on-screen user manual is accessible from under this page menu

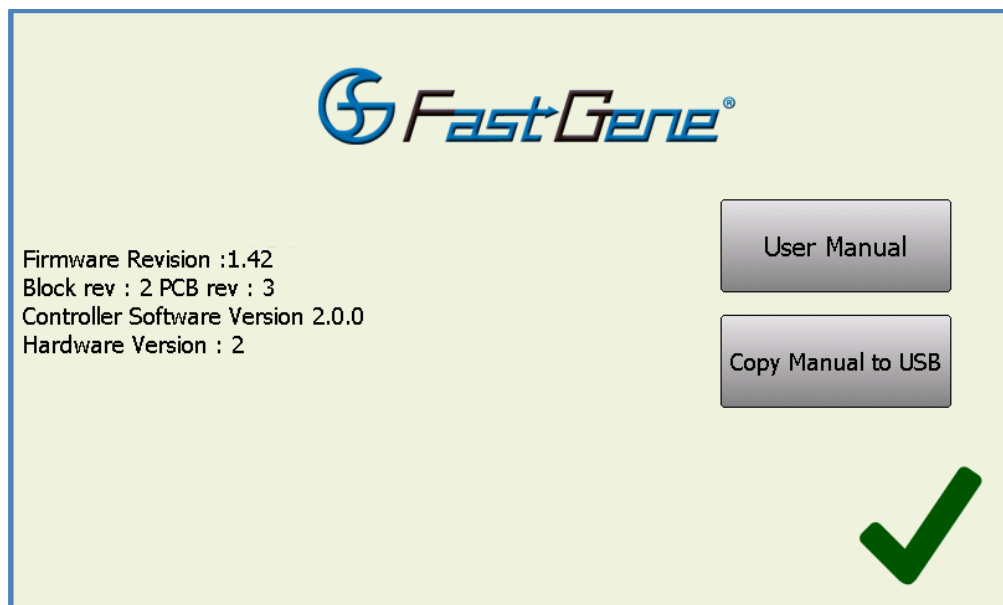

You may also retrieve a PDF copy of the user manual for viewing on a desktop computer or printing a paper copy. To do this insert a USB memory stick into the front port on the instrument, wait a few moments for it to be detected and then press the “Copy Manual to USB” button.

MACHINE SETTINGS – Allows changes to be made to the instruments settings.

Block control settings:

- *'Audible alarm on run completion'* toggles whether there is an audible alarm or just a screen message to alert the operator that the run has completed.
- *'Use Predicted Temperature for Hold times'* The software implements a thermal model which predicts the actual liquid temperature inside the reaction vessels. Hold times can be based on this model (default) or based purely on the block temperature. Using the predicted temperature effectively increases the hold times (and total run time) slightly but gives a more accurate representation of the hold time of the actual sample liquid. Some manufacturers' thermal cyclers purely use the block temperatures for timing.
- *'Accelerated Thermal Equilibration'* If this feature is selected the temperature model will use overshoot and undershoot to get the liquid to temperature faster. This is useful for highly sensitive chemistries or thermal profiles with short hold times.
- *'Auto Resume Run After Power Outage'* If this feature is available on your cycler (not available on all models) then when this box is checked a run will automatically resume at the same place if power should be momentarily lost during a run.
- *'Global rate limit heating cooling rates'* sets the global rate limit for a run. This has a limit of 0.1 °C/sec to 2.5 °C/sec. This feature is only available in runs not manual mode. If any individual step transition is rate limited that setting will take priority for that step over the global setting.

Top heater evaporation control settings:

- *'Use Top Heater'* will cause the top heater to be used during a run if it is checked.
- Entry box for top heater temperature. Temperature is programmable between 30 – 110 °C (default 105 °C)
- Button for manually enabling the top heater to preheat it if required.
- *'Disable top heater when set temperature < 30 deg C'* feature is implemented to reduce the high thermal load placed on the peltiers when holding the samples at low temperatures (i.e. 4 °C). This prevents excess heat from the top heater heating the chilled samples. This feature is not user adjustable.

Note that the top heater is only activated when a run is started or the operator enables it in manual mode.

THERMAL CALIBRATION – The thermal calibration feature is used to adjust the machine calibration. The FastGene® Ultra Cycler is factory calibrated and should not require user recalibration for the life of the machine. The recalibration procedure is not covered in this user manual. If it is required, contact the distributor the equipment was purchased through for thermal calibration testing. The thermal calibration is password protected to prevent it accidentally being changed.

USER ACCOUNTS – User account control.

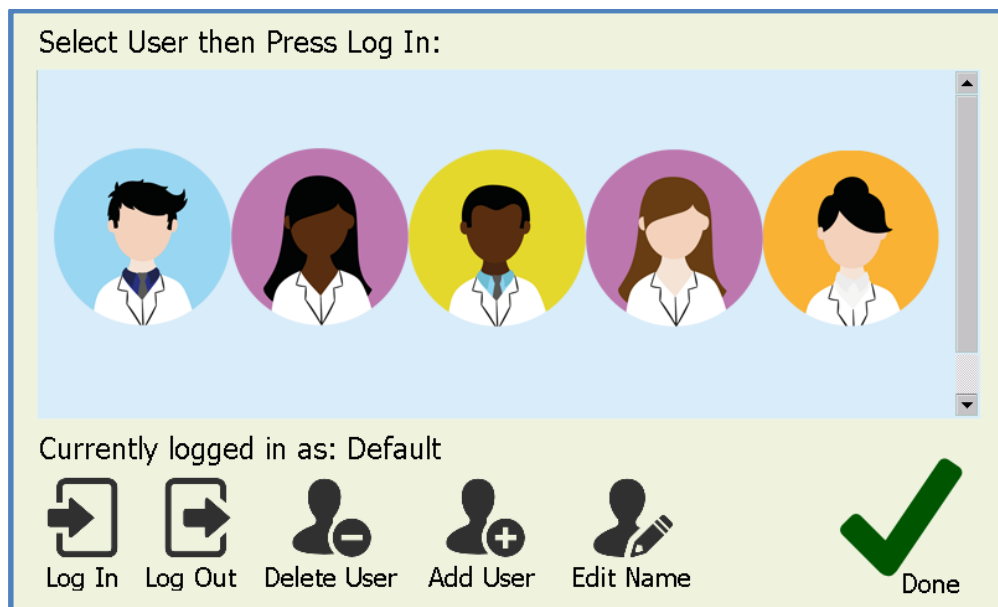

In the user's area you are able to select an existing user or create or delete a user profile. When a user is selected thermal profiles will be loaded or saved to a directory specific to that user. Logging out will change back to default user. To create a new user select the 'Add New User' icon and then enter the user name and choose a user profile image. When adding a new user you have the option of using password protection for log in as that user.

SOFTWARE UPDATE – Allows upgrading of the FastGene® Ultra Cycler operating software.

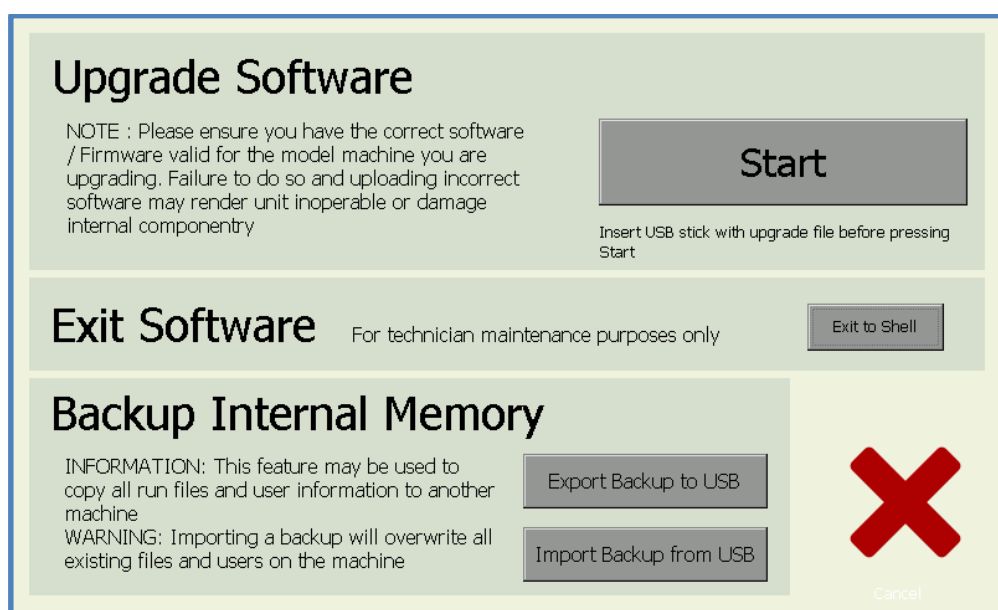

A facility has been provided to update the software which resides on the FastGene® Ultra Cycler.

The upgrade file you receive from your distributor, our support team or the website should be placed on the main root directory of your USB memory stick. You may then select it to upgrade the unit's software. After selecting the software file read the message box and press OK and wait. Upgrade will take up to 1 – 2 minutes. Once upgrade is complete you can check that the new version is installed by visiting the '*Information*' page from the home screen and check the installed software version.

IMPORTANT NOTE: Do not interrupt the unit while a file upgrade is in progress. Switching off the power during upgrade may render the unit inoperable.

After upgrading software the internal on screen user manual may need to also be updated. Go to the system information page and press on screen user manual, it will display an upgrade message if a user manual update is also required. To update it you need to download the correct user manual zip file from our website and unzip it on to the root (main) directory on a USB memory stick and then insert it into the Ultra Cyclor and follow the upgrade prompts when you try to access the out of date help system.

A facility has also been provided to backup the entire user memory (all users and their run files) to a USB memory stick. This backup may then be loaded on to another instrument thus easily providing all the users and files on multiple instruments without needing to individually set them up.

TIME & DATE – Used to set the Time for the instruments internal clock.

TOUCH PANEL CALIBRATION – You can also perform a calibration of the touch-screen interface using the calibration wizard. If the calibration has varied click on this button and follow the instructions to re-calibrate the screen. If you are having difficulties navigating to this option because the touch screen is out of calibration then you may use a USB mouse plugged into the front USB port to reach the touch screen calibration setup.

13. User Tips

It is recommended before you use the device for the first time with biological samples that you experiment with setting up runs and trialling these to familiarise yourself with the machine to ensure correct operation on your valuable samples.

To achieve the maximum lifespan and best clarity from you Ultra Cyclor touch-screen please only use the stylus provided (or equivalent) or your fingers for selecting on the touch-screen. Using a ball point pen, pencil or anything sharp will cause the screen to scratch or be permanently damaged. Note that screen damage is not covered by the warranty.

To maximise the lifespan from the peltier devices which effect the heating and cooling there are a number of actions the user may take:

Do not run the unit with no tubes in the plate and the lid closed. When the lid is closed and no tubes are present the top heater rests close to the 96 well block and will place high thermal load on the peltier devices. Extended operation in this situation will shorten the lifespan of the peltier devices.

Attempt to minimise the time holding the samples at below ambient temperatures longer than required. It is recommended against using the device as a refrigerator to hold samples at 4 °C temperature for long periods of time if you wish to maximise the lifespan of your instrument.



DO NOT operate the system with the block temperature below ambient temperature with the lid open. This may cause excessive condensation to form on the block and excessive liquid run off may occur causing unintended issues. Always operate with the lid closed if the block is set to below ambient or cold temperatures.



The heated lid applies substantial pressure to the tubes to ensure they are well seated into the thermal block and prevent the caps or sealing film from popping off with the increased vapour pressure inside the tube. When using only a single or small number of individual tubes then it is advised you place an empty tube in each of the 4 corners of the block to help absorb the pressure. This will help prevent budget, or thin wall plastic ware from deforming under the high temperature and pressures.

The Top Heater evaporation control default is 105 °C. This is suitable for most applications. If you find that you are getting excess condensation forming at the top of your tubes you can try increasing this temperature to 110 °C or higher.

14. Terms of Use

END USER LICENCE AGREEMENT FastGene® Ultra Cyclor

IMPORTANT: THIS END USER LICENCE AGREEMENT (or "EULA") IS A LEGAL AGREEMENT BETWEEN THE PERSON, COMPANY, OR ORGANIZATION THAT HAS PURCHASED THIS EQUIPMENT ("YOU" OR "CUSTOMER") AND NIPPON GENETICS EUROPE GmbH. BY USING THIS DEVICE, CUSTOMER AGREES TO THE TERMS OF THIS AGREEMENT. IF YOU DO NOT AGREE TO BE BOUND BY THESE TERMS, OR DO NOT HAVE AUTHORITY TO BIND CUSTOMER TO THESE TERMS, THEN DO NOT CONTINUE, AND RETURN THE DEVICE TO YOUR PLACE OF PURCHASE FOR A REFUND IN ACCORDANCE WITH ITS REFUND POLICIES.

1. Definitions:

- (a) "Supplier" means NIPPON Genetics EUROPE GmbH or one of its distributors.
- (b) "Device" means FastGene® Ultra Cyclor Thermal Cyclor.
- (c) "Region" means the country, group of countries or area in which device is located.
- (d) "Features" means software or hardware operational functionality.

2. License Grants

Customer is only granted rights to use the device features which are offered to them in the region in which device was purchased and resides. Customer warrants that the selected region is the true region of its purchase and physical operational location. Incorrect selection of region is in breach of supplier terms of license and may or may not breach any 3rd party license terms. Customer accepts sole responsibility for incorrect region selection and consequences of any breach of 3rd party intellectual property associated with said features.

3. Limitation of Liability

Use of device and any results or information generated by device are at the sole risk of customer. Supplier makes no guarantees that expected functions are performed correctly. Supplier strongly recommends that customer perform full manner of internal controls within their reaction volumes to satisfy themselves that expected functions were performed correctly. Supplier's sole responsibility is for repair or replacement of defective device within the warranty period. Maximum liability of supplier in any circumstance is limited to the amount paid by customer to the supplier for the device.

NIPPON Genetics EUROPE

Binsfelder Strasse 77

52351 Dueren

Germany

Fon: +49 2421 55 496 0

Fax: +49 2421 55 496 11

www.nippongenetics.eu

www.nippongenetics.de

www.n-genetics.com